

Przed rozpoczęciem montażu proszę zapoznać się z instrukcją.
 Before installation, please read the the instructions.
 Vor der Montage bitte die Anleitung genau lesen.
 Před zahájením montáže se seznámte s návodem.
 Pred začiatkom montáže si prečítajte návod.
 A szerelés folyamat megkezdése előtt kérem, hogy figyelmesen olvassa át a szerelési utasítást.

Narzędzia niezbędne do montażu (nie dostarczane przez producenta)
 Tools required for assembly (not provided by the manufacturer)
 Für die Montage notwendige Werkzeuge (nicht vom Hersteller mitgeliefert)
 Nástroje nezbytné pro montáž (nejsou dodávány výrobcem)
 Nástroje nevyhnutné pre montáž (nedodávané výrobcom)
 A szereléshez szükséges szerszámokat (a Gyártó nem biztosítja)

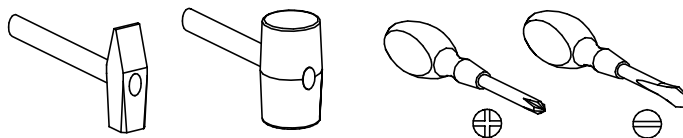
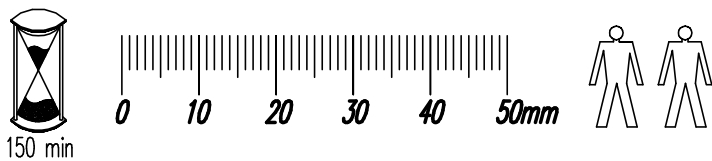

INSTRUKCJA MONTAŻU
 ASSEMBLY INSTRUCTIONS
 MONTAGEANLEITUNG
 NÁVOD NA MONTÁŽ
 NÁVOD NA MONTÁŽ
 SZERELÉSI UTASÍTÁS

LIZBONA LIZBONA 2

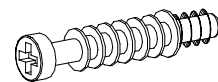
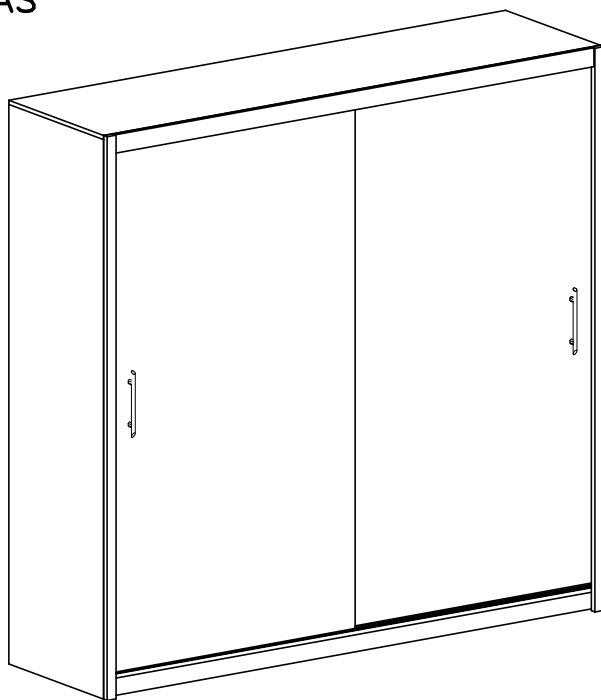

C - 4 St.



O - 12 St.

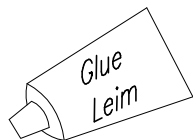

Y - 1 St.



F - 100 St.

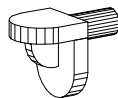

U - 24 St.



T - 1 St.

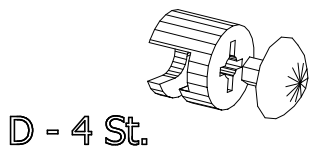

D - 4 St.

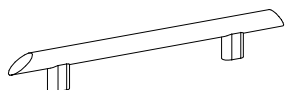

E - 2 St.

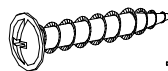

J - 4 St.
 4 x 30 mm

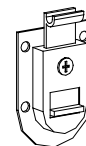

N - 4 St.

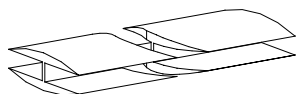

H - 1 St.

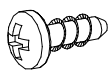

G - 16 St.
 4 x 13 mm

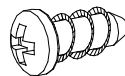

L - 16 St.
 6 x 13 mm



K - 4 St.

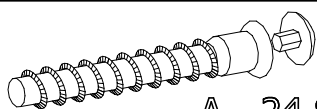

A - 24 St.
 7 x 50 mm



B - 40 St.

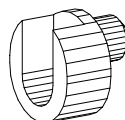

P - 2 St.

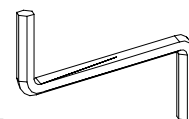

Z - 1 St.

1

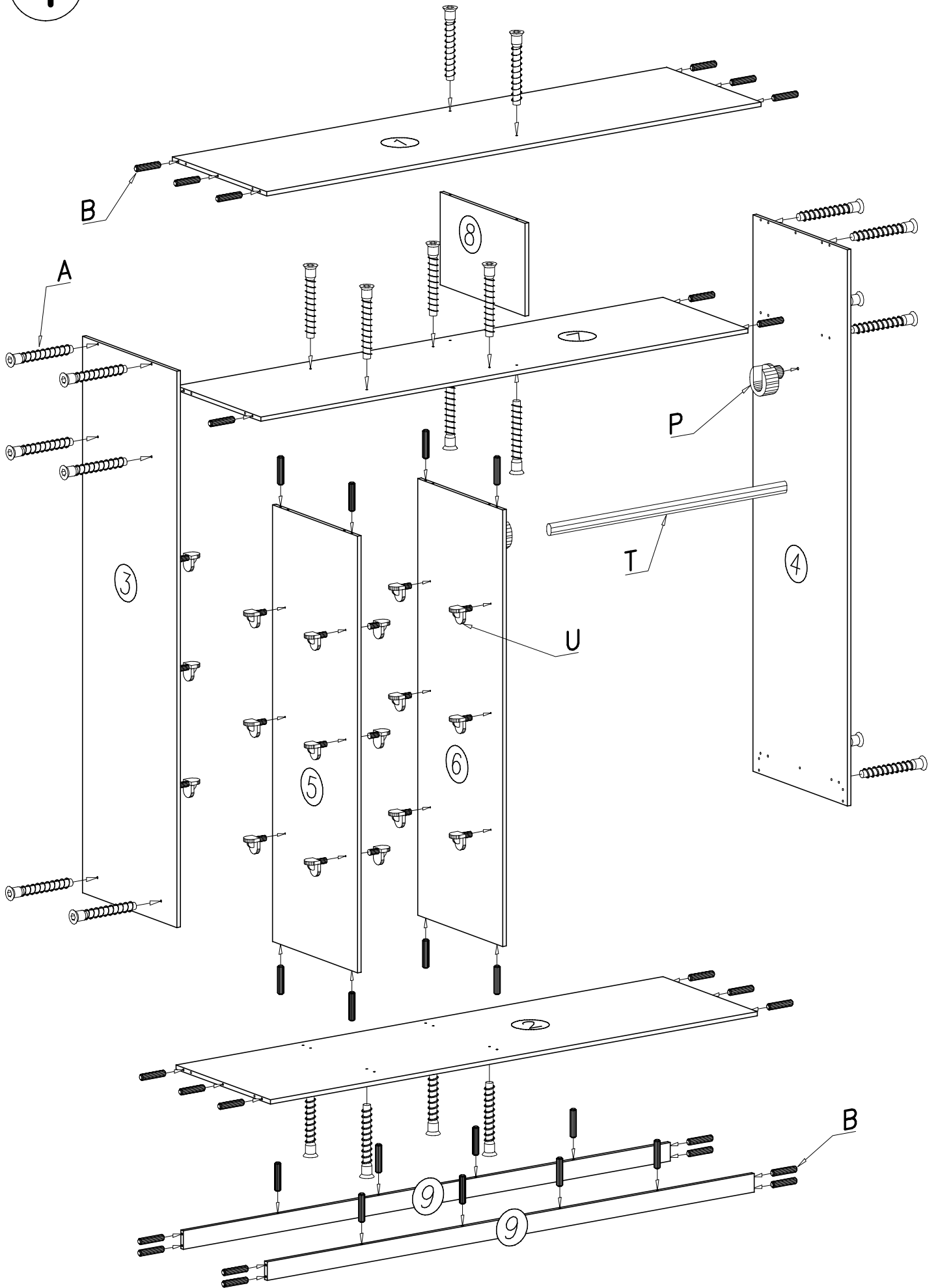

2

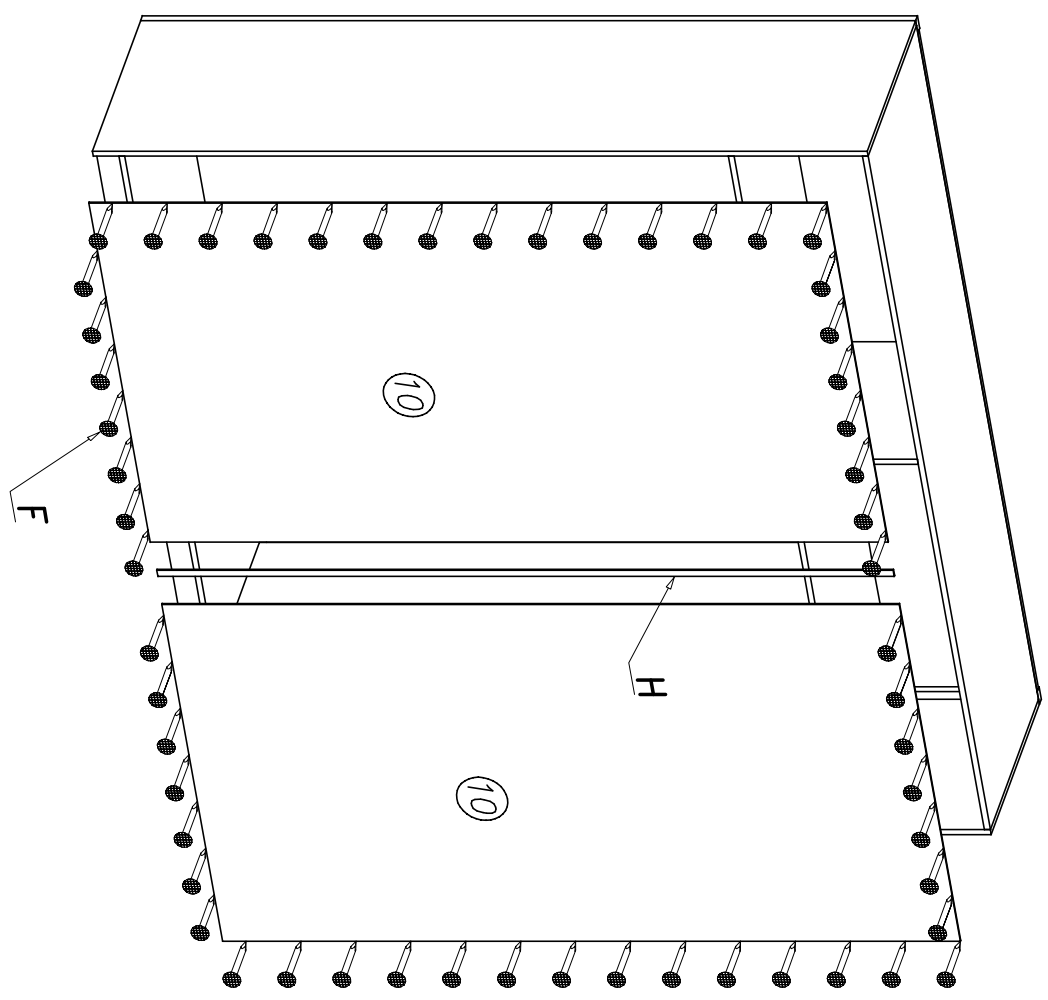

3

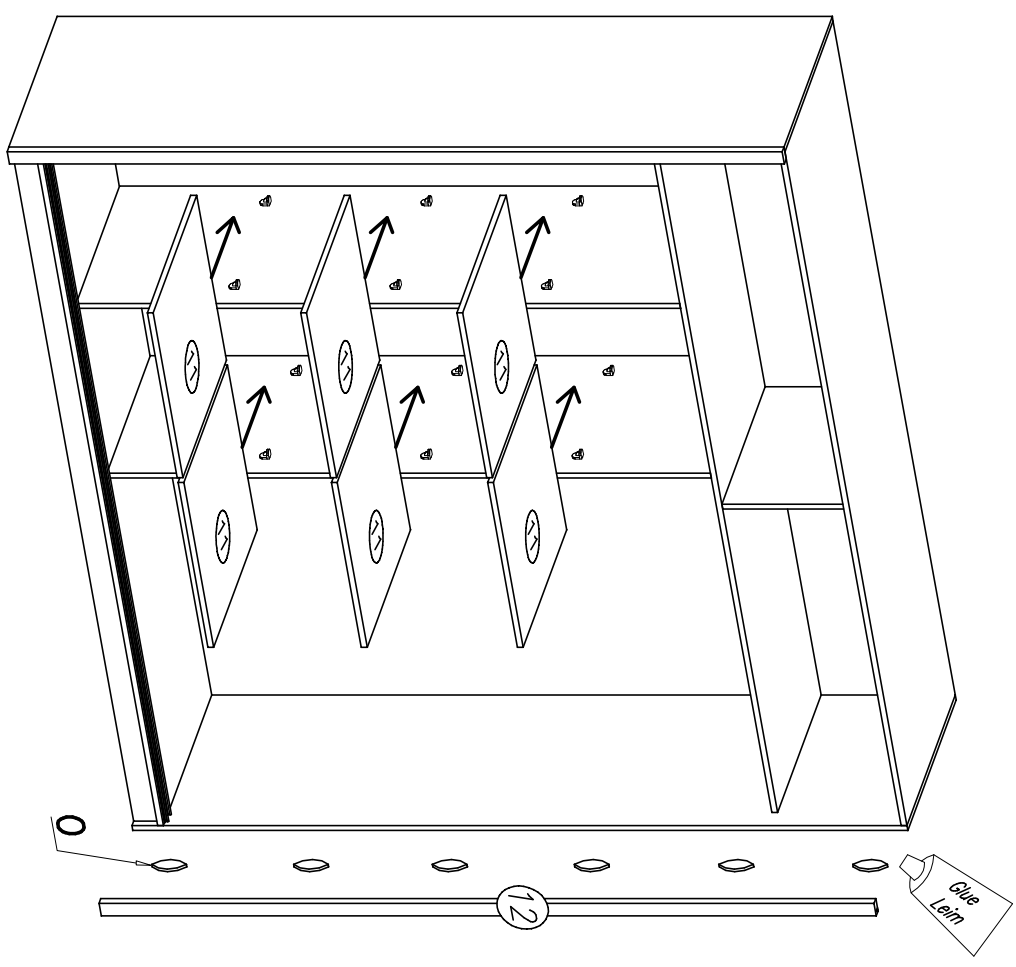

4

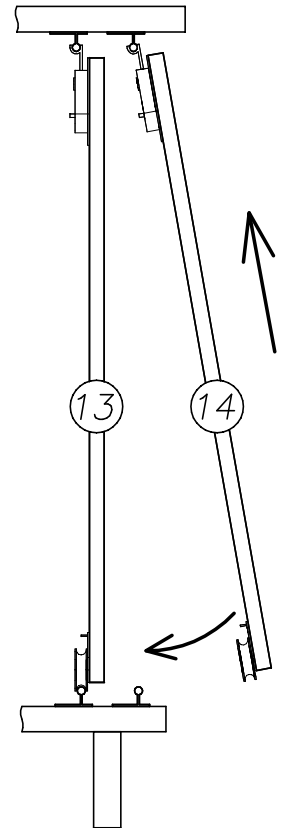
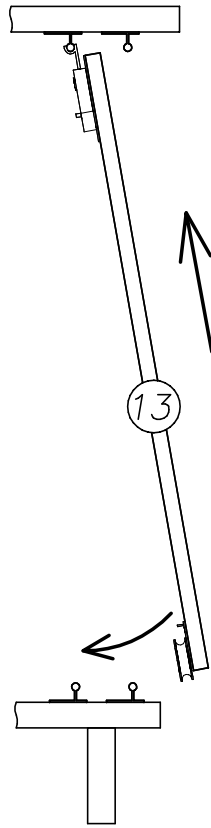
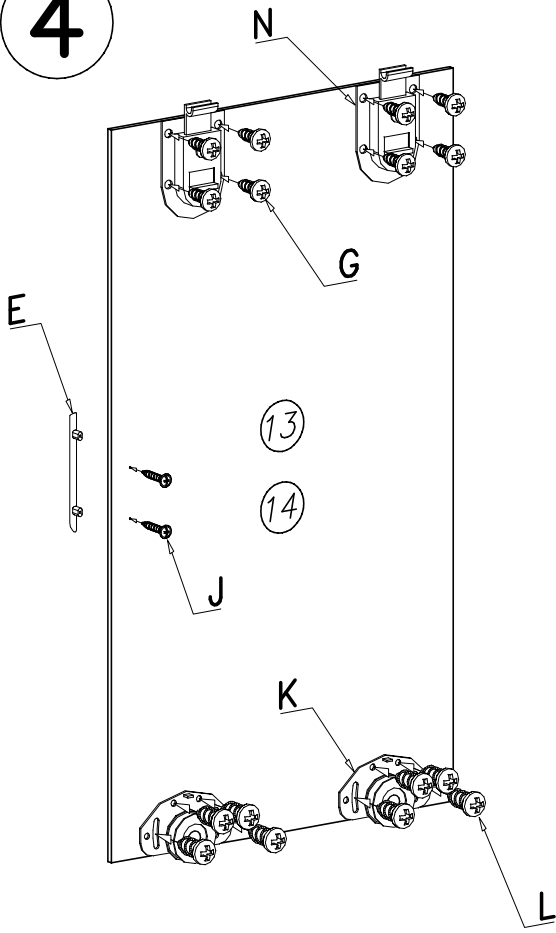

5

